

G41H Handheld Thermal Camera



HIKMICRO G41H handheld thermal camera is specially designed for temperature measurement. It's equipped with a 480 × 360 resolution thermal detector. It helps the staff to quickly find the high-temperature targets in the environment. Meanwhile, it provides assistance with decisions and ensures safety. The device is mainly applied to various industries, such as Building, Electrical utilities, oil and gas industry, etc.

Key Feature

- High sensitivity thermal module with 480 × 360 resolution
- Supports multiple palettes
- High quality optical module with 8 MP resolution
- Bi-spectrum image fusion, picture-in-picture preview
- Wide temperature measurement range: -20°C to 2000°C
- High temperature measurement accuracy: Up to $\pm 2^{\circ}\text{C}$, $\pm 2\%$
- High-calibre 800 × 480 resolution 4.3" LCD touch display
- Long-distance laser light supplement for thermography targets
- LED light supplement makes the device a torch in required scenarios
- Supports 1.0x to 8.0x continuous digital zoom

▪ Specification

Infrared Image	
IR Resolution	480 x 360 (172,800 pixels)
SuperIR	960 x 720 (691,200 pixels)
NETD	< 35 mK (@ 25 °C, F#=1.0)
Image Frequency	50 Hz
Detector Pitch	17 μm
Spectral Range	7.5 to 14 μm
Focal Length	25 mm
F-number	F 1.0
Field of View (FOV)	18.7° × 14°
Spatial Resolution (IFOV)	0.68 mrad
Min. Focus Distance	0.3 m (0.98 ft)
Focus Mode	Laser Assisted AF/Continuous AF/AF/Manual Focus/Touch AF
Focus Speed	Approx. 2 second
Image Display	
Visual Camera	3264 × 2448 (8 MP)
Display	800 × 480 Resolution, 4.3" LCD Touch Screen
Screen Brightness	Manual/Auto
Digital Zoom	1.0x to 8.0x continuous
Color Palettes	White Hot, Black Hot, Rainbow, Ironbow, Red Hot, Fusion, Rain, Blue Red
Focus Mode Palette	Above/Below/Interval
Color Alarm	Above/Below/Interval/Insulation
Image Modes	Infrared/Visual/Fusion/PIP/Blending
Measurement and Analysis	
Object Temperature Range	-20 °C to 2000 °C (-4 °F to 3632 °F)
Accuracy	Max (±2°C/3.6°F, ±2%)
Measurement Tools	Center Spot, Hot Spot, Cold Spot User-definable: 10 spots, 1 line, 5 rectangles, and 5 circle
Level and Span Mode	Auto/Manual/1-Tap Touch-screen
Inspection Route	Yes
Data Storage and Communication	
Storage Media	Removable 64 GB Micro SD Card
Image Storage Capacity	Approx. 60,000 Images
Annotations	Voice note: max. 60 seconds; Text note: max. 200 characters
Video Storage Capacity	Approx. 54 hours
Video File Format	MP4 video and radiometric video
General	
Wi-Fi	802.11 b/g/n (2.4 GHz and 5 GHz)
Bluetooth	Bluetooth 4.2
USB Interface	USB Type-C
HDMI Interface	Yes
Laser	Yes, Class II, Wavelength: 635 nm; Power: < 1 mW

Laser Distance Meter	Indoor distance: 50 m (164 ft); Outdoor distance: 10 m (33 ft).
GPS & Compass	Yes
Battery Type	Interchangeable and rechargeable Li-ion battery
Battery Operating Time	Approx. 4 hours
Battery Charging Time	Approx. 4 hours fully charged
Power Saving Mode	Yes
Protection Level	IP54, IEC 60529
Drop Test Height	2 m (6.56 ft), IEC 60068-2-31
Safety	IEC 61010-1
EMC	EN 301 489-1, EN 301 489-17, EN IEC 61000-6-2, EN IEC 61000-6-3
Vibration	2 g, IEC 60068-2-6
Shock	25 g, IEC 60068-2-27
Working Temperature Range	-20°C to 50°C (-4°F to 122°F)
Storage Temperature Range	-20°C to 60°C (-4°F to 140°F)
Relative Humidity	< 95% non-condensing
Weight	Approx. 1058 g (2.33 lb)
Dimension	284.7 × 120.6 × 124.5 mm (11.21 × 4.75 × 4.9 in)
Tripod Mounting	UNC ¼"-20
LED Light	Yes

▪ Available Model

HM-TP74H-25SVF/W-G41H

▪ Dimension

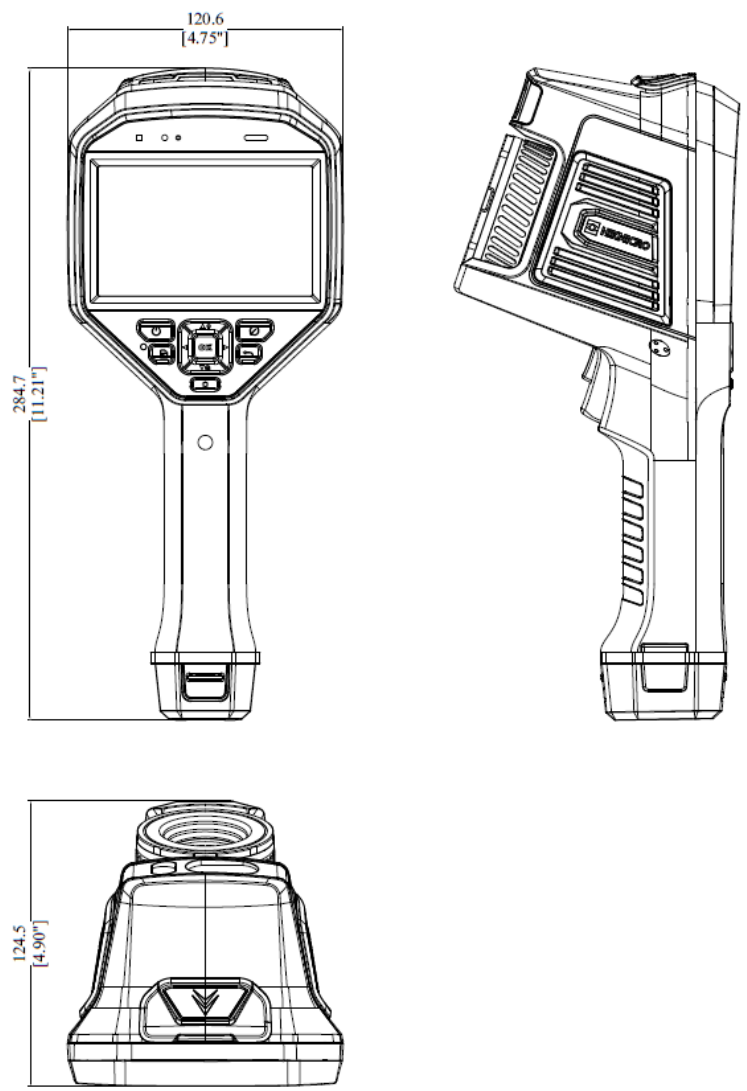

Unit: mm [inch]

▪ Optional Accessories



HM-G605-LENS1



HM-G620-LENS1



HM-5202ZC2



HM-SP01-POUCH



INR18650-35E-1S2P









HM-701ZJ-G01-SHIELD



HM-G630-LENS1

COMPLIANCE NOTICE: The thermal series products might be subject to export controls in various countries or regions, including without limitation, the United States, European Union, United Kingdom and/or other member countries of the Wassenaar Arrangement. Please consult your professional legal or compliance expert or local government authorities for any necessary export license requirements if you intend to transfer, export, re-export the thermal series products between different countries.



 HIKMICRO Thermography  hikmicro_thermography  HIKMICRO Thermography  HIKMICRO  info@hikmicrotech.com  <http://hikmicrotech.com/en>

© 2023 Hangzhou HIKMICRO Sensing Technology Co., Ltd. All Rights Reserved.
Data subject to change without notice!